

Type	Instrument	Location	Introduction	Operating Manual	Service Request	Technician Contact Information		Examiner Contact Information	Charge
						Deputy Contact Information	Deputy Contact Information		
Deposition Process Tools	E-Gun Evaporation System I	R133 in NTHU Lab	<a href="#">Link Here</a>	<a href="#">Download</a>	<a href="#">Download</a>	Ms. Kuo TEL: 03 – 5742299 or NTHU Ext. 42299 E-mail : <a href="mailto:kuowenfeng@mx.nthu.edu.tw">kuowenfeng@mx.nthu.edu.tw</a>	(Deputy) Ms. Wu	Ms. Kuo TEL: 03 – 5742299 or NTHU Ext. 42299 E-mail : <a href="mailto:kuowenfeng@mx.nthu.edu.tw">kuowenfeng@mx.nthu.edu.tw</a>	<a href="#">Link Here</a>
	E-Gun Evaporation System II	NTHU Lab Cleanroom	<a href="#">Link Here</a>	<a href="#">Download</a>	<a href="#">Download</a>	Ms. Wu TEL: 03 - 5742291 or NTHU Ext. 42291 E-mail : <a href="mailto:wury@mx.nthu.edu.tw">wury@mx.nthu.edu.tw</a>	(Deputy) Ms. Kuo	Ms. Wu TEL: 03 - 5742291 or NTHU Ext. 42291 E-mail : <a href="mailto:wury@mx.nthu.edu.tw">wury@mx.nthu.edu.tw</a>	<a href="#">Link Here</a>
	E-Gun Evaporation System III		<a href="#">Link Here</a>	<a href="#">Download</a>	<a href="#">Download</a>	Ms. Chang TEL: 03 - 5742298 or NTHU Ext. 42298 E-mail : <a href="mailto:changcw@mx.nthu.edu.tw">changcw@mx.nthu.edu.tw</a>	(Deputy) Ms. Wu	Ms. Chang TEL: 03 - 5742298 or NTHU Ext. 42298 E-mail : <a href="mailto:changcw@mx.nthu.edu.tw">changcw@mx.nthu.edu.tw</a>	<a href="#">Link Here</a>
	Polymer Deposition System (PDS)	NTHU Lab Cleanroom	<a href="#">Link Here</a>	<a href="#">Download</a>	<a href="#">Download</a>	Ms. Wu TEL: 03 - 5742291 or NTHU Ext. 42291 E-mail : <a href="mailto:wury@mx.nthu.edu.tw">wury@mx.nthu.edu.tw</a>	(Deputy) Mr. Sung	Ms. Wu TEL: 03 - 5742291 or NTHU Ext. 42291 E-mail : <a href="mailto:wury@mx.nthu.edu.tw">wury@mx.nthu.edu.tw</a>	<a href="#">Link Here</a>
	SAMCO PECVD System		<a href="#">Link Here</a>	<a href="#">Download</a>	<a href="#">Download</a>	Ms. Wu TEL: 03 - 5742291 or NTHU Ext. 42291 E-mail : <a href="mailto:wury@mx.nthu.edu.tw">wury@mx.nthu.edu.tw</a>	(Deputy) Ms. Chang	Ms. Wu TEL: 03 - 5742291 or NTHU Ext. 42291 E-mail : <a href="mailto:wury@mx.nthu.edu.tw">wury@mx.nthu.edu.tw</a>	<a href="#">Link Here</a>
	DC Sputter System	NTHU Lab Cleanroom	<a href="#">Link Here</a>	<a href="#">Download</a>	<a href="#">Download</a>	Ms. Chang TEL: 03 - 5742298 or NTHU Ext. 42298 E-mail : <a href="mailto:changcw@mx.nthu.edu.tw">changcw@mx.nthu.edu.tw</a>	(Deputy) Ms. Kuo	Ms. Chang TEL: 03 - 5742298 or NTHU Ext. 42298 E-mail : <a href="mailto:changcw@mx.nthu.edu.tw">changcw@mx.nthu.edu.tw</a>	<a href="#">Link Here</a>
	RF Sputter System		<a href="#">Link Here</a>	<a href="#">Download</a>	<a href="#">Download</a>	Ms. Kuo TEL: 03 - 5742299 or NTHU Ext. 42299 E-mail : <a href="mailto:kuowenfeng@mx.nthu.edu.tw">kuowenfeng@mx.nthu.edu.tw</a>	(Deputy) Ms. Chang	Ms. Kuo TEL: 03 - 5742299 or NTHU Ext. 42299 E-mail : <a href="mailto:kuowenfeng@mx.nthu.edu.tw">kuowenfeng@mx.nthu.edu.tw</a>	<a href="#">Link Here</a>
Wet Etching Process Tools	Lithography Area in NTHU Lab Cleanroom A. Wet Bench (2 Sets) B. Spin Coater C. Hot Plate & Hood	NTHU Lab Cleanroom	<a href="#">Link Here</a>	<a href="#">A Download</a> <a href="#">B Download</a> <a href="#">C Download</a>		Mr. Sung TEL: 03 - 5742290 or NTHU Ext.42290 E-mail : <a href="mailto:sungmy@mx.nthu.edu.tw">sungmy@mx.nthu.edu.tw</a>	(Deputy) Ms. Kuo	Mr. Sung TEL: 03 - 5742290 or NTHU Ext.42290 E-mail : <a href="mailto:sungmy@mx.nthu.edu.tw">sungmy@mx.nthu.edu.tw</a>	<a href="#">Link Here</a>
	Chemical area in NTHU Lab (Station I & Station II & Station III)		<a href="#">Link Here</a>	<a href="#">Download</a>	<a href="#">Download</a>	Ms. Chang TEL: 03 - 5742298 or NTHU Ext. 42298 E-mail : <a href="mailto:changcw@mx.nthu.edu.tw">changcw@mx.nthu.edu.tw</a>		Ms. Chang TEL: 03 - 5742298 or NTHU Ext. 42298	<a href="#">Link Here</a>

						Mr. Sung TEL: 03 - 5742290 or NTHU Ext. 42290 E-mail : <a href="mailto:sungmy@mx.nthu.edu.tw">sungmy@mx.nthu.edu.tw</a>	E-mail : <a href="mailto:changcw@mx.nthu.edu.tw">changcw@mx.nthu.edu.tw</a>	
Dry Etching Process Tools								
	Reactive Ion Etcher (RIE)	NTHU Lab Cleanroom	<a href="#">Link Here</a>	<a href="#">Download</a>	<a href="#">Download</a>	Mr. Sung TEL: 03 - 5742290 or NTHU Ext. 42290 E-mail : <a href="mailto:sungmy@mx.nthu.edu.tw">sungmy@mx.nthu.edu.tw</a>  (Deputy) Ms. Kuo	Mr. Sung TEL: 03 - 5742290 or NTHU Ext. 42290 E-mail : <a href="mailto:sungmy@mx.nthu.edu.tw">sungmy@mx.nthu.edu.tw</a>	<a href="#">Link Here</a>
	EVG610 Double Side Aligner		<a href="#">Link Here</a>	<a href="#">Link Here</a>	<a href="#">Link Here</a>	Mr. Sung TEL: 03 - 5742290 or NTHU Ext.42290 E-mail : <a href="mailto:sungmy@mx.nthu.edu.tw">sungmy@mx.nthu.edu.tw</a>  (Deputy) Ms. Chang	Mr. Sung TEL: 03 - 5742290 or NTHU Ext.42290 E-mail : <a href="mailto:sungmy@mx.nthu.edu.tw">sungmy@mx.nthu.edu.tw</a>	<a href="#">Link Here</a>
Lithography Tools	DLP Maskless Exposure System	NTHU Lab Cleanroom	<a href="#">Link Here</a>	<a href="#">Download</a>	<a href="#">Download</a>	Ms. Cheng TEL: 03 - 5715131 Ext. 33313 E-mail : <a href="mailto:cnmm1015@gmail.com">cnmm1015@gmail.com</a>  (Deputy) Dr. Sun-Zen Chen Ext. 42285 E-mail : <a href="mailto:szchen@mx.nthu.edu.tw">szchen@mx.nthu.edu.tw</a>	Ms. Cheng TEL: 03 - 5715131 Ext. 33313 E-mail : <a href="mailto:cnmm1015@gmail.com">cnmm1015@gmail.com</a>	<a href="#">Link Here</a>
	EVG620		<a href="#">Link Here</a>	<a href="#">Download</a>	<a href="#">Download</a>	Ms. Kuo TEL: 03 - 5742299 or NTHU Ext. 42299 E-mail : <a href="mailto:kuowenfeng@mx.nthu.edu.tw">kuowenfeng@mx.nthu.edu.tw</a>  (Deputy) Mr. Sung	Ms. Kuo TEL: 03 - 5742299 or NTHU Ext. 42299 E-mail : <a href="mailto:kuowenfeng@mx.nthu.edu.tw">kuowenfeng@mx.nthu.edu.tw</a>	<a href="#">Link Here</a>
	NX2000 Nano Imprint System		<a href="#">Link Here</a>	<a href="#">Download</a>		Mr. Sung TEL: 03 - 5742290 or NTHU Ext.42290 E-mail : <a href="mailto:sungmy@mx.nthu.edu.tw">sungmy@mx.nthu.edu.tw</a>  (Deputy) Ms. Tai	Mr. Sung TEL: 03 - 5742290 or NTHU Ext.42290 E-mail : <a href="mailto:sungmy@mx.nthu.edu.tw">sungmy@mx.nthu.edu.tw</a>	<a href="#">Link Here</a>
	E-beam lithography System	R130 in NTHU Lab	<a href="#">Link Here</a>	<a href="#">Download</a>	<a href="#">Download</a>	Ms. Cheng TEL: 03 - 5715131 Ext. 33313 E-mail : <a href="mailto:cnmm1015@gmail.com">cnmm1015@gmail.com</a>  (Deputy) Dr. Sun-Zen Chen Ext. 42285 E-mail : <a href="mailto:szchen@mx.nthu.edu.tw">szchen@mx.nthu.edu.tw</a>	Ms. Cheng TEL: 03 - 5715131 Ext. 33313 E-mail : <a href="mailto:cnmm1015@gmail.com">cnmm1015@gmail.com</a>	<a href="#">Link Here</a>
Other Tools	O <sub>2</sub> Plasma Cleaning System	NTHU Lab Cleanroom	<a href="#">Link Here</a>	<a href="#">Download</a>	<a href="#">Download</a>	Ms. Kuo TEL: 03 - 5742299 or NTHU Ext. 42299 E-mail : <a href="mailto:kuowenfeng@mx.nthu.edu.tw">kuowenfeng@mx.nthu.edu.tw</a>  (Deputy) Ms. Tai	Ms. Kuo TEL: 03 - 5742299 or NTHU Ext. 42299 E-mail : <a href="mailto:kuowenfeng@mx.nthu.edu.tw">kuowenfeng@mx.nthu.edu.tw</a>	<a href="#">Link Here</a>
	RTP		<a href="#">Link Here</a>	<a href="#">Download</a>	<a href="#">Download</a>	Ms. Wu TEL: 03 - 5742291 or NTHU Ext. 42291 E-mail : <a href="mailto:wury@mx.nthu.edu.tw">wury@mx.nthu.edu.tw</a>  (Deputy) Mr. Sung	Ms. Wu TEL: 03 - 5742291 or NTHU Ext. 42291 E-mail : <a href="mailto:wury@mx.nthu.edu.tw">wury@mx.nthu.edu.tw</a>	<a href="#">Link Here</a>

UV & Ozone Dry Stripper		<a href="#">Link Here</a>	<a href="#">Download</a>	<a href="#">Download</a>	<p>Ms. Chang            TEL: 03 - 5742298 or NTHU Ext. 42298            E-mail : <a href="mailto:changcw@mx.nthu.edu.tw">changcw@mx.nthu.edu.tw</a></p> <p>(Deputy) Ms. Kuo</p>	<p>Ms. Chang            TEL: 03 - 5742298 or NTHU Ext. 42298            E-mail : <a href="mailto:changcw@mx.nthu.edu.tw">changcw@mx.nthu.edu.tw</a></p>	<a href="#">Link Here</a>
α-step (Surface profiler System)		<a href="#">Link Here</a>	<a href="#">Download</a>		<p>Ms. Kuo            TEL: 03 - 5742299 or NTHU Ext. 42299            E-mail : <a href="mailto:kuowenfeng@mx.nthu.edu.tw">kuowenfeng@mx.nthu.edu.tw</a></p> <p>(Deputy) Ms. Cheng</p>	<p>Ms. Kuo            TEL: 03 - 5742299 or NTHU Ext. 42299            E-mail : <a href="mailto:kuowenfeng@mx.nthu.edu.tw">kuowenfeng@mx.nthu.edu.tw</a></p>	<a href="#">Link Here</a>
Spectroscopic Ellipsometer		<a href="#">Link Here</a>		<a href="#">Download</a>	<p>Ms. Wu            TEL: 03 - 5742291 or NTHU Ext. 42291            E-mail : <a href="mailto:wury@mx.nthu.edu.tw">wury@mx.nthu.edu.tw</a></p> <p>(Deputy) Ms. Tai</p>	<p>Ms. Wu            TEL: 03 - 5742291 or NTHU Ext. 42291            E-mail : <a href="mailto:wury@mx.nthu.edu.tw">wury@mx.nthu.edu.tw</a></p>	<a href="#">Link Here</a>

1150521 update

**【Characterization Instrument List & Charges】**

Type	Instrument	Location	Introduction	Service Request	Technician Contact Information	Examiner Contact Information	Charge
Electron Microscope	Field Emission Scanning Electron Microscope (JSM-7000F)	R131 in NTHU Lab	<a href="#">Link Here</a>	<a href="#">Download</a>	Ms. Tai TEL: 03 - 5742292 or NTHU Ext. 42288/35332/42292 E-mail : <a href="mailto:yhtai@mx.nthu.edu.tw">yhtai@mx.nthu.edu.tw</a>	Ms. Tai TEL: 03 - 5742292 or NTHU Ext. 42288/35332/42292 E-mail : <a href="mailto:yhtai@mx.nthu.edu.tw">yhtai@mx.nthu.edu.tw</a>	<a href="#">Link Here</a>
	Field Emission Scanning Electron Microscope (JSM-IT800)		<a href="#">Link Here</a>	<a href="#">Download</a>	Ms. Tai TEL: 03 - 5742292 or NTHU Ext. 42288/35332/42292 E-mail : <a href="mailto:yhtai@mx.nthu.edu.tw">yhtai@mx.nthu.edu.tw</a>	Ms. Tai TEL: 03 - 5742292 or NTHU Ext. 42288/35332/42292 E-mail : <a href="mailto:yhtai@mx.nthu.edu.tw">yhtai@mx.nthu.edu.tw</a>	<a href="#">Link Here</a>
	High Vacuum Scanning Probe Microscope (SPM)	R132 in NTHU Lab	<a href="#">Link Here</a>	<a href="#">Download</a>	Ms. Tai TEL: 03 - 5742292 or NTHU Ext. 42288/35332/42292 E-mail : <a href="mailto:yhtai@mx.nthu.edu.tw">yhtai@mx.nthu.edu.tw</a>	Ms. Tai TEL: 03 - 5742292 or NTHU Ext. 42288/35332/42292 E-mail : <a href="mailto:yhtai@mx.nthu.edu.tw">yhtai@mx.nthu.edu.tw</a>	<a href="#">Link Here</a>
	High Resolution Transmission Electron Microscope (HRTEM)	R110 in Materials Science Laboratory	<a href="#">Link Here</a>	<a href="#">Download</a>	Ms. Lai 03 – 5715131 Ext. 42287/31032 E-mail : <a href="mailto:siyilai@mx.nthu.edu.tw">siyilai@mx.nthu.edu.tw</a>	<u>No self - operation</u>	<a href="#">Link Here</a>
	Dual-beam Focused Ion Beam System (FIB) (Zeiss Crossbeam System)	R122 in NTHU Lab	<a href="#">Link Here</a>	<a href="#">Download</a>	Ms. Lai 03 – 5715131 Ext. 42287/31032 E-mail : <a href="mailto:siyilai@mx.nthu.edu.tw">siyilai@mx.nthu.edu.tw</a>	Ms. Lai 03 – 5715131 Ext. 42287/31032 E-mail : <a href="mailto:siyilai@mx.nthu.edu.tw">siyilai@mx.nthu.edu.tw</a>	<a href="#">Link Here</a>
	Dual-beam Focused Ion Beam System (FIB) (FEI Helios Nanolab 600i System) (Service Suspended)	R122 in NTHU Lab	<a href="#">Link Here</a>	<a href="#">Download</a>	Ms. Lai 03 – 5715131 Ext. 42287/31032 E-mail : <a href="mailto:siyilai@mx.nthu.edu.tw">siyilai@mx.nthu.edu.tw</a>	Ms. Lai 03 – 5715131 Ext. 42287/31032 E-mail : <a href="mailto:siyilai@mx.nthu.edu.tw">siyilai@mx.nthu.edu.tw</a>	<a href="#">Link Here</a>
	Solar Cell	Solar Simulator (Service Suspended)	R132 in NTHU Lab	<a href="#">Link Here</a>	<a href="#">Download</a>	Ms. Tai TEL: 03 - 5742292 or NTHU Ext. 42288/35332/42292 E-mail : <a href="mailto:yhtai@mx.nthu.edu.tw">yhtai@mx.nthu.edu.tw</a>	Ms. Tai TEL: 03 - 5742292 or NTHU Ext. 42288/35332/42292 E-mail : <a href="mailto:yhtai@mx.nthu.edu.tw">yhtai@mx.nthu.edu.tw</a>
Incident Photon Conversion Efficiency (IPCE) (Service Suspended)		<a href="#">Link Here</a>		<a href="#">Download</a>	Ms. Tai TEL: 03 - 5742292 or NTHU Ext. 42288/35332/42292 E-mail : <a href="mailto:yhtai@mx.nthu.edu.tw">yhtai@mx.nthu.edu.tw</a>	Ms. Tai TEL: 03 - 5742292 or NTHU Ext. 42288/35332/42292 E-mail : <a href="mailto:yhtai@mx.nthu.edu.tw">yhtai@mx.nthu.edu.tw</a>	<a href="#">Link Here</a>

# E-Gun Evaporation System (I)

[Back to](#)  
[\[ Instrument List \]](#)

## 【 Instrument introduction 】

### 1. Brand Model: ULVAC



### 2. Application

The system can deposit Al、Ti、Au、Pt、Cu、Cr metal film.

### 3. Equipment Specifications

- Power supply: Maximum 300 W ◦
- Substrate heating: 0~300 °C ◦
- Operating pressure:  $< 8 \times 10^{-6}$  torr ◦
- Crucible size: 10 cc ◦

#### ※ Notices

The chamber can accept 4 inch (12 pieces) or 6 inch (3 pieces) and if your wafer size less than 4 inch, please use the heat resistant tape to fix your sample on the 4-inch wafer.

We can accept the maximum deposit film 800nm thickness.

For the process procedure include from load the sample in the chamber and wait the process temperature down to the room temperature and then finish pump down procedure

The Center support metal source include Ti、Al、Cu、Cr.

We can help customer do the ODM to deposit Au、Pt film.

We will charge from this form. (The costs of materials are listed below.)

Instrument	List of Charge	NTHU	Academics	Industry	
E-gun I (Consumable cost for E- gun I)	Common metal	Cu、Al	NTD 75/hr	NTD 115/hr	NTD 150/hr
		Cr、Ti	NTD 150/hr	NTD 200/hr	NTD 300/hr
	List of Charge		NTHU	OTHERS	
	Noble metal	Au	NTD 7,641/g	NTD 9,551/g	
		Pt	NTD 3,000/g	NTD 3,750/g	
		<ul style="list-style-type: none"><li>• Prices are subject to change according to market rates without prior notice.</li><li>• Effective May 1, 2026, charges for noble metals will be calculated based on the actual weight used.</li><li>• The costs of common metals are basing on the processing time, and the maximum charge is up to 4 hours.</li></ul>			
The user should check the integrity of both the source material and the crucible with the					

corresponding technician when he/she borrows the target as well as turns it back. Any damages to the target will certainly transfer the charge to the user.

## E-Gun Evaporation System (I)

[Back to](#)  
[\[Instrument List\]](#)

### 【Service & Charge】

**Preferential schemes (Effective Date: October 10, 2025):**

**【Generous discount】** : The professor/advisor who prepay 100,000 NT can have a 30% discount on self-operating charges and a 20% discount on manufacturing service.

**【VIP discount】** : The professor/advisor who prepay 500,000 NT can have a 50% discount on self-operating and a 30% discount on manufacturing service.

Note 1: Please pay the overdraft first before you want to attend the preferential scheme.

Note 2: You can use your preferential scheme until the prepayment is run out.

Note 3: The preferential scheme is only used for the charges of self-operating, and manufacturing service excludes the consumables, license charges, and others.

Note 4: The charge is calculated by the unit of 15 minutes when the using time exceeds the necessary charge hours.

Instrument/ List of Charge		NTHU	Academics	Industry
E-Gun Evaporation System I  (The processing time includes the time of vacuuming, depositing, and cooling. The necessary charge hours are 2 hours.)	Charge of manufacturing service	NTD 25/min	NTD 37/min	NTD 50/min
	The cost of the consumable will additionally charge based on the use of material.			
	Charge of Self-Operating	NTD 12/min	NTD 18/min	NTD 24/min

## 【Instrument introduction】

### 1. Brand : FSE



### 2. Application

Evaporation of oxide film by E-gun

### 3. Specifications

- Operating pressure:  $< 6.5 \times 10^{-6}$  torr
- Wafer Size: 4 inch Wafer\*4 or 6 inch Wafer\*4; If it is chip, it must be fixed on Wafer fist by your-self.
- Provide material types:  $\text{SiO}_2$  、  $\text{Al}_2\text{O}_3$  、  $\text{TiO}_2$

## 【Service & Charge】

**Preferential schemes (Effective Date: October 10, 2025):**

**【Generous discount】** : The professor/advisor who prepay 100,000 NT can have a 30% discount on self-operating charges and a 20% discount on manufacturing service.

**【VIP discount】** : The professor/advisor who prepay 500,000 NT can have a 50% discount on self-operating and a 30% discount on manufacturing service.

Note 1: Please pay the overdraft first before you want to attend the preferential scheme.

Note 2: You can use your preferential scheme until the prepayment is run out.

Note 3: The preferential scheme is only used for the charges of self-operating, and manufacturing service excludes the consumables, license charges, and others.

Note 4: The charge is calculated by the unit of 15 minutes when the using time exceeds the necessary charge hours.

Instrument/ List of Charge		NTHU	Academics	Industry
E-Gun Evaporation System II  (The processing time includes the time of vacuuming, depositing, and cooling. The necessary charge hours are 2 hours.)	Charge of manufacturing service	NTD 25/min	NTD 37/min	NTD 50/min
	<b>The cost of the consumable will additionally charge based on the use of material.</b>			
	Charge of Self-Operating	NTD 12/min	NTD 18/min	NTD 24/min
Instrument/ List of Charge		NTHU	Academics	Industry
E-gun II Material Charge	SiO <sub>2</sub>	NTD 75/hr	NTD 113/hr	NTD 150/hr
	Al <sub>2</sub> O <sub>3</sub>	NTD 100/hr	NTD 150/hr	NTD 200/hr
	TiO <sub>2</sub>	NTD 125/hr	NTD 188/hr	NTD 250/hr

# Polymer Deposition System (PDS)

[Back to](#)  
[\[Instrument List\]](#)

## 【Instrument introduction】

### 1. Brand and model : PDS2010



### 2. Application

Parylene coating

### 3. Specifications

- Parylene C、N、D
- Wafer size :4"、6" wafer and chip
- Cavity volume 4"wafer \*9 or 6"wafer \*3

# Polymer Deposition System (PDS)

[Back to  
【Instrument List】](#)

## 【Service & Charge】

**Preferential schemes (Effective Date: October 10, 2025):**

**【Generous discount】** : The professor/advisor who prepay 100,000 NT can have a 30% discount on self-operating charges and a 20% discount on manufacturing service.

**【VIP discount】** : The professor/advisor who prepay 500,000 NT can have a 50% discount on self-operating and a 30% discount on manufacturing service.

Note 1: Please pay the overdraft first before you want to attend the preferential scheme.

Note 2: You can use your preferential scheme until the prepayment is run out.

Note 3: The preferential scheme is only used for the charges of self-operating, and manufacturing service excludes the consumables, license charges, and others.

Note 4: The charge is calculated by the unit of 15 minutes when the using time exceeds the necessary charge hours.

Instrument/ List of Charge		NTHU	Academics	Industry
Polymer Deposition System (PDS) <b>(The processing time includes the time of vacuuming, heating, depositing, and cooling. The necessary charge hours are 8 hours.)</b>	Charge of manufacturing service	NTD 11/min	NTD 16/min	NTD 22/min

## 【Instrument introduction】

### 1. Brand and model : Samco PD-220N



### 2. Application

For  $\text{SiO}_2$  ( $\text{SiH}_4 + \text{N}_2\text{O}$ ) &  $\text{Si}_3\text{N}_4$  ( $\text{SiH}_4 + \text{NH}_3 + \text{N}_2$ ) Deposition ; TEOS-Oxide(Characterization service only) ◦

### 3. Specifications

- Wafer size: chin~ 4" silicon wafer ◦ (size over 4" please contact with the technician first)
- RF Power: <200W
- Temperature: < 300 °C ◦
- Uniformity : < 5 % ◦

## 【Service & Charge】

**Preferential schemes (Effective Date: October 10, 2025):**

**【Generous discount】** : The professor/advisor who prepay 100,000 NT can have a 30% discount on self-operating charges and a 20% discount on manufacturing service.

**【VIP discount】** : The professor/advisor who prepay 500,000 NT can have a 50% discount on self-operating and a 30% discount on manufacturing service.

Note 1: Please pay the overdraft first before you want to attend the preferential scheme.

Note 2: You can use your preferential scheme until the prepayment is run out.

Note 3: The preferential scheme is only used for the charges of self-operating, and manufacturing service excludes the consumables, license charges, and others.

Note 4: The charge is calculated by the unit of 15 minutes when the using time exceeds the necessary charge hours.

Instrument/ List of Charge		NTHU	Academics	Industry
SAMCO PD-220N (The processing time includes the time of depositing and cleaning. The necessary charge hours are 2 hours.)	Charge of manufacturing service	NTD 25/min	NTD 37/min	NTD 50/min
	Charge of Self-Operating	NTD 11/min	NTD 16/min	NTD 22/min

# DC Sputter System

[Back to](#)  
[【Instrument List】](#)

## 【Instrument introduction】

1. Brand and model : ULVAC Co. Japan (Vacuum system: ULVAC Mechanical pump & ULVAC Cryo pump 16P)

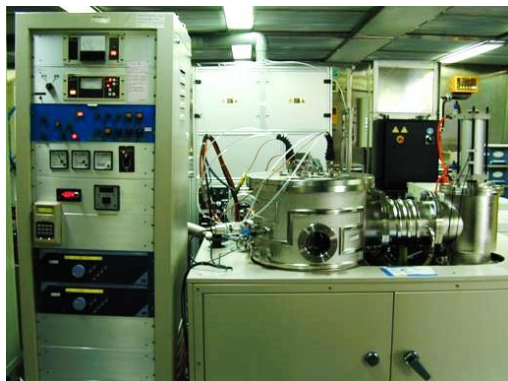

### 2. Application

Sputtering Ti · Pt · Ni · Cu · Ag · W · Au · Al · Cr · Mo

### 3. Important specifications

- Process gas: Ar
- Wafer size: 4 inch silicon wafer, maximum 8 wafers per run ◦
- Power supply: maximum 100 ~ 300 W ◦
- Operating pressure:  $8 \times 10^{-6}$  torr ◦

※ Note :

This equipment could accept break wafers (please attach it onto a 4 inch full wafer.)

Please describe your target thickness and materials, and draw the cross-sectional view of your wafer on the application form.

Precious metal will be charged depends on used weigh, and the charge should be paid right after usage by cash. Please check the metal charge standard below.

Instrument	List of Charge		NTHU	Academics	Industry	
DC Sputter (Consumable cost for DC Sputter)	Common metal	Cu · Al	NTD 150/10min	NTD 200/10min	NTD 250/10min	
		Cr · Ti	NTD 250/10min	NTD 380/10min	NTD 500/10min	
		W · Ni	NTD 400/10min	NTD 550/10min	NTD 700/10min	
		Ag	NTD 600/10min	NTD 800/10min	NTD 1,000/10min	
	List of Charge		NTHU		OTHERS	
	Noble metal	Au	NTD 7,641/g	NTD 9,551/g		
		Pt	NTD 3,000/g	NTD 3,750/g		
	<ul style="list-style-type: none"> <li>▪ Prices are subject to change according to market rates without prior notice.</li> <li>▪ For a standard manufacturing service, the charge of consumable is up to 30 minutes. However, the material cost for a customized service is basing on the process.</li> <li>▪ Effective May 1, 2026, charges for noble metals will be calculated based on the actual weight used.</li> </ul>					

- The user should check the integrity of both the source material and the crucible with the corresponding technician when he/she borrows the target as well as turns it back. Any damages to the target will certainly transfer the charge to the user.
- The noble metals are not allowed to borrow. If you want to deposit the noble metal film via DC Sputter, please send a request for a manufacturing service.

# DC Sputter System

[Back to](#)  
[【Instrument List】](#)

## 【Service & Charge】

**Preferential schemes (Effective Date: October 10, 2025):**

**【Generous discount】** : The professor/advisor who prepay 100,000 NT can have a 30% discount on self-operating charges and a 20% discount on manufacturing service.

**【VIP discount】** : The professor/advisor who prepay 500,000 NT can have a 50% discount on self-operating and a 30% discount on manufacturing service.

Note 1: Please pay the overdraft first before you want to attend the preferential scheme.

Note 2: You can use your preferential scheme until the prepayment is run out.

Note 3: The preferential scheme is only used for the charges of self-operating, and manufacturing service excludes the consumables, license charges, and others.

Note 4: The charge is calculated by the unit of 15 minutes when the using time exceeds the necessary charge hours.

Instrument/ List of Charge		NTHU	Academics	Industry
DC Sputter System  (The processing time includes the time of vacuuming, depositing, and cooling. The necessary charge hours are 2.5 hours and 3 hours for manufacturing service and self-operating respectively.)	Charge of manufacturing service	NTD 25/min	NTD 37/min	NTD 50/min
		The cost of the consumable will additionally charge based on the use of material.		
	Charge of Self-Operating	NTD 8/min	NTD 12/min	NTD 16/min

## 【Instrument introduction】

### 1. Brand and Model : ULVAC RFS-200S



### 2. Purpose

Sputter deposition of  $\text{TiO}_2$ ,  $\text{TIN}$ ,  $\text{Ti}$  on the substrate

### 3. Specifications

- Sputtering power supply: RF: 50~300W, DC pulse: 60-300W
- Main pump: CRYO pump
- Ultimate chamber pressure:  $1 \times 10^{-6}$  TORR
- Uniformity: 4" wafer: < 5%
- This equipment is a single chip process: 4 inch\*1 or 1 inch\*6 (Choose one to use)
- The maximum flow rate of nitrogen and oxygen is 30 sccm
- The machine has a bias function (the upper limit of use must be lower than 150 V)
- The machine has a heating function (the upper limit of use must be lower than 350 °C)

#### ※Notice:

1. This machine is a research experimental machine and the users need to prepare their own targets.
2. The use of equipment includes vacuum relief and sample input + process + cooling + sample retrieval + vacuum establishment. After that, the users can log out of the system.
3. Please do not leave the site during the manufacturing process (not including cooling).
4. There is only one-piece Ti target in the center. Please register with the administrative Ms. Wan-Chin Chuang if you want to borrow the target material.

The specifications of the copper backplane are as follows

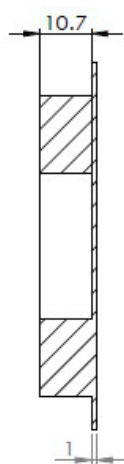
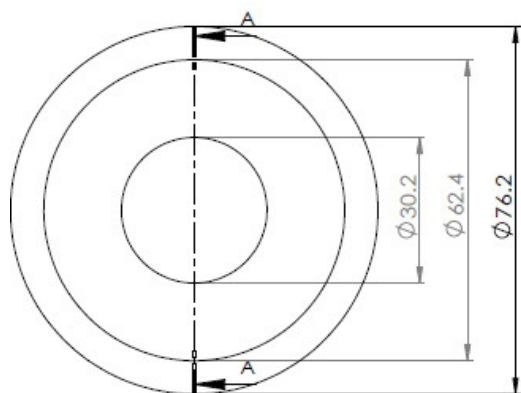

剖面圖 A-A

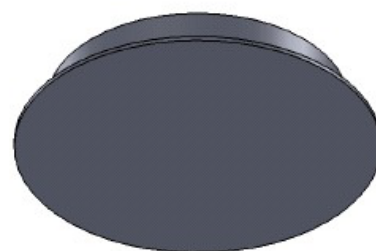
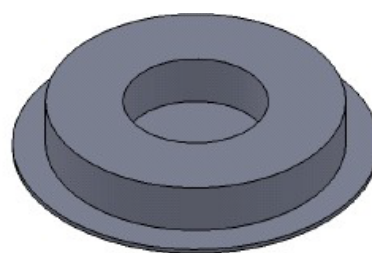

If you use the copper backplane provided by the center, you need to order a 3-inch round target with a thickness of 4 mm.

If you purchase one-piece targets, the specifications are as follows:

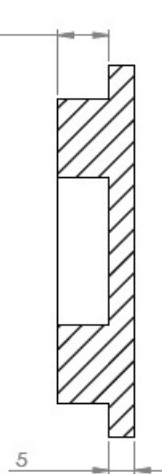
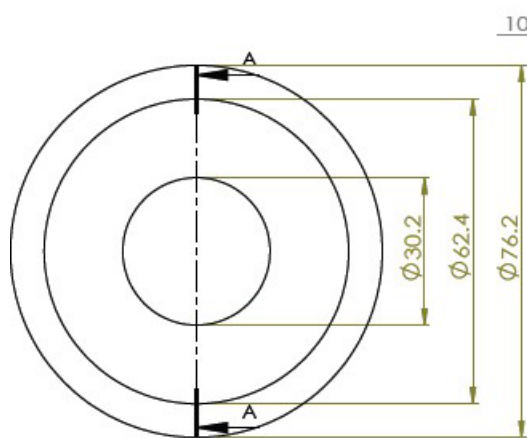

剖面圖 A-A

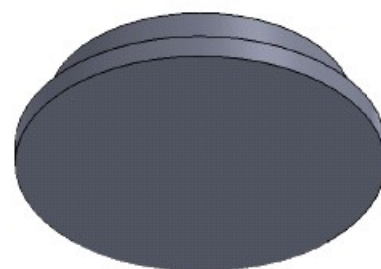
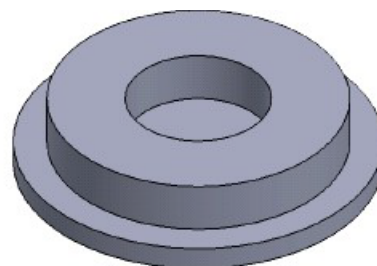

## 【Service & Charge】

**Preferential schemes (Effective Date: October 10, 2025):**

**【Generous discount】** : The professor/advisor who prepay 100,000 NT can have a 30% discount on self-operating charges and a 20% discount on manufacturing service.

**【VIP discount】** : The professor/advisor who prepay 500,000 NT can have a 50% discount on self-operating and a 30% discount on manufacturing service.

Note 1: Please pay the overdraft first before you want to attend the preferential scheme.

Note 2: You can use your preferential scheme until the prepayment is run out.

Note 3: The preferential scheme is only used for the charges of self-operating, and manufacturing service excludes the consumables, license charges, and others.

Note 4: The charge is calculated by the unit of 15 minutes when the using time exceeds the necessary charge hours.

Instrument/ List of Charge		NTHU	Academics	Industry
RF Sputter System (The processing time includes the time of vacuuming, cooling, and operating time. Minimum usage hours: entrusted operation: 2 hrs self-operation: 2.5 hrs)	Charge of manufacturing service	NTD 25/min	NTD 37/min	NTD 50/min
	Charge of Self-Operating	NTD 10/min	NTD 15/min	NTD 20/min

# Field Emission Scanning Electron Microscope

(JSM-IT800)

[Back to](#)  
[【Instrument List】](#)

## 【Instrument introduction】

1. Brand : JSM-IT 800 (Semi-In-Lens) ◦



## 2 ◦ Application

- Surface structures inspection on the samples such as metal, ceramics and polymer, etc.
- Energy Dispersive Spectrometer (EDS) is capable of detecting elements, provides a qualitative identification and semi-quantitative analysis .

## 3 ◦ Specification

- Voltage : 0.5 to 30 KV ◦
- Magnification : 30 to 500000 ◦
- Resolution : 0.8nm (15 KV) ◦ 0.7 nm (1KV) ◦ 3.0 nm (15KV, 5 nA) ◦

**Note: Magnetic materials are prohibited from being placed in the device**

## 4 ◦ Auto Fine Coater

The JEOL Smart Coater (JEC-3000FC) is a fully automated sputter coater that applies a fine grained gold or platinum (option) coating on samples for imaging in a scanning electron microscope.

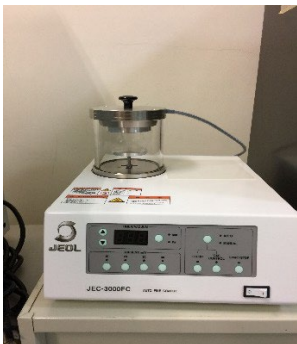

## 5 ◦ Air Isolated Transfer System

JEOL has built a special air-lock system that can handle the transfer of air-sensitive specimens to be imaged in the SEM without atmospheric exposure. Applications include: components in rechargeable batteries, fuel cells,

and catalysts among others. Any exposure to oxygen or moisture in the air can completely alter or destroy the structure of these highly reactive materials.

Transfer vessel



# Field Emission Scanning Electron Microscop

(JSM-IT800)

## 【Service & Charge】

Preferential schemes (Effective Date: October 10, 2025):

【Generous discount】 : The professor/advisor who prepay 100,000 NT can have a 30% discount on self-operating charges and a 20% discount on manufacturing service.

【VIP discount】 : The professor/advisor who prepay 500,000 NT can have a 50% discount on self-operating and a 30% discount on manufacturing service.

Note :

1. The charge is calculated by the unit of 15 minutes when the using time exceeds the necessary charge hours.
2. The fee schedule has been effective since May 15, 2025.

Instrument/ List of Charge		NTHU	Academics	Industry
Field Emission Scanning Electron Microscope  (The necessary charge hour is 2 hour for manufacturing service and self-operating respectively.)  (The necessary charge hours are 2 hours for visiting activites.)	Charge of Characterization Service	NTD 2,400/hr	NTD 3,500/hr	NTD 5,500/hr
		【Fee of report】 An additional NTD2000 is required for CNMM formal report.		
	Charge of Self-Operating	NTD 1,500/hr	NTD 2,500/hr	NTD 4,500/hr
	transfer vessel	1600 each time		
	Auto Fine coater	NTD 200/10mins	NTD 300/10mins	NTD 400/10mins

# Lithography Area in NTHU Lab Cleanroom

【Wet Bench (2 Sets) & Spin Coater & Hot Plate & Hood】

## 【Instrument introduction】

[Back to  
【Instrument List】](#)

### 1. Brand and Model



### 2. Equipment Specifications

Wafer should be less than 6 inches (including 6 inches wafer)

#### ※ Attention

- If the experiment contains metal or Acetone, please operate on the left half of cleaning bench (operation in the right half of cleaning bench is prohibited). The right half of cleaning bench is used for lithography process. (The area operated by the two cleaning benches, the left half area is operated metal and the right half area is operated by lithography process).
- Acidic chemicals and alkaline chemicals are prohibited to operate in the cleaning bench.
- All areas in the lithography laboratory are shared. Please do not place personal laboratory appliance. If you do not apply to place chemicals or private laboratory appliance, confiscate appliance and charge the relevant fees.
- After using the chemical waste solution, please use the recycling system to recover.

## 【Service & Charge】

From 2024/06, all NTHU Lab Cleanroom users should pay the cleanroom facility charge as entering the cleanroom.

The corresponding fees:

800 NT/day for each person for the Lithography area (A day is defined from 00:00 to 23:59.)

400 NT/day for each person for the Chemical area

100 NT/day for each person for the White-light area (The White-light area is the area within the cleanroom except the regions of Lithography area and Chemical area.)

If the user has used any instruments in the specified area, the cleanroom facility charge will be removed automatically. For example, if a student uses an instrument located in the White-light area, then the expense of the White-light area will not be calculated. If he uses an instrument located in the Lithography area, then the costs of White-light area and Lithography area will be canceled.

### 1. Model

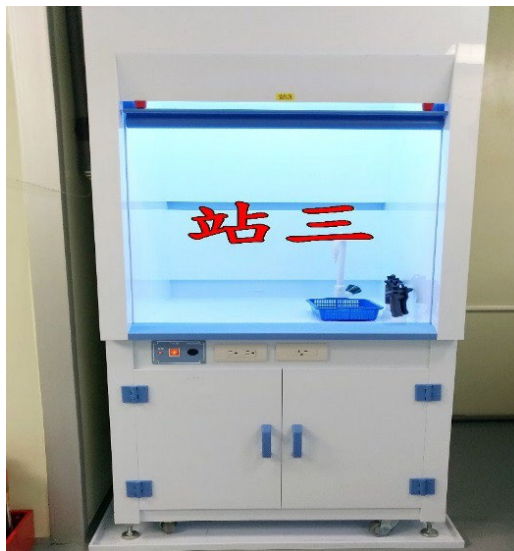

### 2. Application

Cleaning, Wet etching

### 3. Specifications of wafer

4" , 6" , and broken wafer can be used in the Cleanroom.

Cleaning the 4" wafer can borrow the wafer cassette from Miss. Zhuang at CNMM, but cleaning the 6" and broken wafer needs to bring your own wafer cassette.

#### ※ Precautions

- Using the chemical station needs to wear protective equipment and aware of rules and regulations.
- Please write the record book before use, using without record will have a severe penalty.
- Before using sulfuric acid to remove photoresist at station 2, need to use acetone and DI water clean the wafer first.
- To prevent chemical cleaning bench pollution and safety consideration, use DI water clean the bench before the next process.
- Station 3 is only used as auxiliary space for users of Station 1 and Station 2. (Everyone takes turns to use it after coordination.)
- No one is allowed to use chemicals at Station 3.
- To avoid penalties for violations, please read the manual beside the bench or the latest version manual on the website before the operation.
- Please bring your own gas mask.

# Chemical Area in NTHU Lab 【Station I & Station II & Station III】

## 【Service & Charge】

[Back to  
【Instrument List】](#)

Instrument/ List of Charge		NTHU	Academics	Industry
Chemical Area  (Minimum foundry working time is 1hr)  (Daily billing for self-operating)	Charge of manufacturing service	NTD 20/min	NTD 25/min	NTD 30/min
	Charge of Self-Operating	NTD 400/day	NTD 400/day	NTD 400/day

※ The 4" wafer cleaning stander of OEM is use H<sub>2</sub>SO<sub>4</sub> and BOE cleaning. Other cleaning processes must discuss the feasibility with the manager, the fee will cost additional.



## 【Service & Charge】

### Preferential schemes:

**【Generous discount】** : The professor/advisor who prepay 50,000 NT can have a 20% discount on manufacturing service.

**【VIP discount】** : The professor/advisor who prepay 500,000 NT can have a 35% discount on manufacturing service.

Note 1: Please pay the overdraft first before you want to attend the preferential scheme.

Note 2: You can use your preferential scheme until the prepayment is run out.

Note 3: The preferential scheme is only used for the charges of self-operating, and manufacturing service excludes the consumables, license charges, and others.

Note 4: The charge is calculated by the unit of 15 minutes when the using time exceeds the necessary charge hours.

Instrument/ List of Charge		NTHU	Academics	Industry
	Charge of manufacturing service			

## 【Instrument introduction】

### 1. Model : DektakXT



### 2. Purpose

Two-dimensional surface profile measurement and analysis

Three-dimensional measurement analysis (not open to use), if you have special needs, please contact the manager to discuss.

### 3. Specifications

Stage Size	Max:6 inch
Force	1-10mg
Tip radius	2 $\mu\text{m}$
Vertical range	smaller than 1mm
Measurable minimum depth and height	Nano-scale film
Sample thickness	50 mm
Scan range	55 mm
Camera	3.1 million pixel
Step repeatability	1 sigma at 1000 $\text{\AA}$ , the standard step film must be less than 4 $\text{\AA}$ ,

#### ※Notice:

- If the material is soft, you can set Stylus Force to 1.
- If the size of measured sample is smaller than 2\*2 cm, please stick it on the large-size blank by yourself.

## 【Service & Charge】

**Preferential schemes (Effective Date: October 10, 2025):**

**【Generous discount】** : The professor/advisor who prepay 100,000 NT can have a 30% discount on self-operating charges and a 20% discount on manufacturing service.

**【VIP discount】** : The professor/advisor who prepay 500,000 NT can have a 50% discount on self-operating and a 30% discount on manufacturing service.

Note 1: Please pay the overdraft first before you want to attend the preferential scheme.

Note 2: You can use your preferential scheme until the prepayment is run out.

Note 3: The preferential scheme is only used for the charges of self-operating, and manufacturing service excludes the consumables, license charges, and others.

Note 4: The charge is calculated by the unit of 15 minutes when the using time exceeds the necessary charge hours.

Instrument/ List of Charge		NTHU	Academics	Industry
Surface profiler System (The minimum charge of manufacturing service is 1 hr)	Charge of manufacturing service	/	25 NTD/min	30 NTD/min
	Charge of Self-Operating	10/ min	15 NTD/min	20 NTD/min

## 【Instrument introduction】

[Back to  
【Instrument List】](#)

## 【 Service & Charge 】

[Back to  
【Instrument List】](#)

### Preferential schemes:

**【Generous discount】** : The professor/advisor who prepay 50,000 NT can have a 50% discount on self-operating charges and a 20% discount on manufacturing service.

**【VIP discount】** : The professor/advisor who prepay 500,000 NT can have a 70% discount on self-operating and a 35% discount on manufacturing service.

Note 1: Please pay the overdraft first before you want to attend the preferential scheme.

Note 2: You can use your preferential scheme until the prepayment is run out.

Note 3: The preferential scheme is only used for the charges of self-operating, and manufacturing service excludes the consumables, license charges, and others.

Note 4: The charge is calculated by the unit of 15 minutes when the using time exceeds the necessary charge hours.

Instrument/ List of Charge		NTHU	Academics	Industry
	Charge of manufacturing service			
	Charge of Self-Operating			

# Spectroscopic Ellipsometer

[Back to](#)  
[\[Instrument List\]](#)

## 【Instrument introduction】

### 1. Brand and model : JA Woollam (Model: M2000)

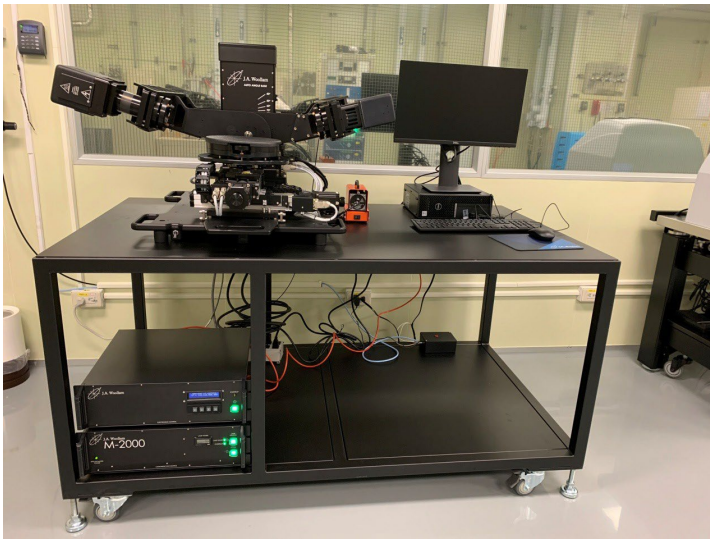

### 2. Purpose

Measure the film thickness in a non-contact, non-destructive way.

### 3. Specifications

- (1) Measuring spectrum range: 245nm – 1000nm
- (2) Light source: 75-watt xenon lamp
- (3) Measurement method: With automatic variable measurement angle, the measurement angle can be set through the computer, and the incident angle range is from 45 degrees to 90 degrees
- (4) stage form: 200mm  $\pm$  10mm sample table size, movement stroke: X- the Y are both 100mm  $\pm$  10mm ; with vacuum suction horizontal platform, need comprise a vacuum pump
- (5) measuring thickness range: 5 nm to 5  $\mu$ m
- (6) Substrate types: Si, Glass, Quartz, stainless steel
- (7) Types of thin film materials: organic polymer materials, nitrides, semiconductor materials, dielectric materials, metal materials, etc.

### 4. Measurable items

- (1) Film thickness
- (2) Optical constants of the film or substrate material (ex: refractive index n, extinction coefficient k)
- (3) Film surface roughness
- (4) Multilayer materials

### 5. Attention

- (1) The recommended size of the test piece is larger than 2\*2cm<sup>2</sup>
- (2) The currently open self-operated and measurable films are: SiO<sub>2</sub>, SiN<sub>x</sub>, Ta<sub>2</sub>O<sub>5</sub>, Al<sub>2</sub>O<sub>3</sub>, SiC; please contact the administrator for other films to be measured.

## 【Service & Charge】

**Preferential schemes (Effective Date: October 10, 2025):**

**【Generous discount】** : The professor/advisor who prepay 100,000 NT can have a 30% discount on self-operating charges and a 20% discount on manufacturing service.

**【VIP discount】** : The professor/advisor who prepay 500,000 NT can have a 50% discount on self-operating and a 30% discount on manufacturing service.

Note 1: Please pay the overdraft first before you want to attend the preferential scheme.

Note 2: You can use your preferential scheme until the prepayment is run out.

Note 3: The preferential scheme is only used for the charges of self-operating, and manufacturing service excludes the consumables, license charges, and others.

Note 4: The charge is calculated by the unit of 15 minutes when the using time exceeds the necessary charge hours.

Instrument/ List of Charge		NTHU	Academics	Industry
<b>Spectroscopic Ellipsometer</b>  (Clean process and operating time are included in the billing, the minimum usage time is 1hr)	Charge of manufacturing service		NTD 35/min	NTD 45/min
	Charge of Self-Operating	NTD 15/min	NTD 25/min	NTD 35/min

# 【Instrument introduction】

一、Brand and model :

二、Applications

三、Important specifications

※ Notification

## 【Service & Charge】

### Preferential schemes:

**【Generous discount】** : The professor/advisor who prepay 50,000 NT can have a 50% discount on self-operating charges and a 20% discount on manufacturing service.

**【VIP discount】** : The professor/advisor who prepay 500,000 NT can have a 70% discount on self-operating and a 35% discount on manufacturing service.

Note 1: Please pay the overdraft first before you want to attend the preferential scheme.

Note 2: You can use your preferential scheme until the prepayment is run out.

Note 3: The preferential scheme is only used for the charges of self-operating, and manufacturing service excludes the consumables, license charges, and others.

Note 4: The charge is calculated by the unit of 15 minutes when the using time exceeds the necessary charge hours.

Instrument/ List of Charge		NTHU	Academics	Industry
	Charge of manufacturing service			
	Charge of Self-Operating			

# Reactive Ion Etcher (RIE)

[Back to](#)  
[【Instrument List】](#)

## 【Instrument introduction】

### 1. Manufactory & Model : CNT-RPA08



### 2. Applications

Etch Silicon base

### 3. Important specifications

- RF Power : 50~300W,13.56 MHz ◦
- Gas : CF<sub>4</sub>、SF<sub>6</sub>、CHF<sub>3</sub>、O<sub>2</sub>、Ar ◦
- Main pump: Turbo pump ◦
- Process pressure : 5~300 mTorr ◦

#### ※ Note

- Wafer size : 1\*1 cm<sup>2</sup> ~ 6-inch Full wafer
- Etching mask : PR、Silicon oxide、Silicon nitride、Cr、Al
- The wafer CAN NOT contain Au, Cu, Pt, Fe, Co, Ni...etc. and its oxide.

## 【Service & Charge】

**Preferential schemes (Effective Date: October 10, 2025):**

**【Generous discount】** : The professor/advisor who prepay 100,000 NT can have a 30% discount on self-operating charges and a 20% discount on manufacturing service.

**【VIP discount】** : The professor/advisor who prepay 500,000 NT can have a 50% discount on self-operating and a 30% discount on manufacturing service.

Note 1: Please pay the overdraft first before you want to attend the preferential scheme.

Note 2: You can use your preferential scheme until the prepayment is run out.

Note 3: The preferential scheme is only used for the charges of self-operating, and manufacturing service excludes the consumables, license charges, and others.

Note 4: The charge is calculated by the unit of 15 minutes when the using time exceeds the necessary charge hours.

Instrument/ List of Charge		NTHU	Academics	Industry
Reactive Ion Etcher (RIE) (The processing time includes the time of etching and cleaning. The necessary charge hours are 1 hours.)	Charge of manufacturing service	NTD 25/min	NTD 37/min	NTD 50/min
	Charge of Self-Operating	NTD 12/min	NTD 18/min	NTD 24/min

## 【Instrument introduction】

— 、 Brand and model :

二 、 Applications

- 

三 、 Specifications

-

## 【 Service & Charge 】

### Preferential schemes:

**【 Generous discount 】** : The professor/advisor who prepay 50,000 NT can have a 50% discount on self-operating charges and a 20% discount on manufacturing service.

**【 VIP discount 】** : The professor/advisor who prepay 500,000 NT can have a 70% discount on self-operating and a 35% discount on manufacturing service.

Note 1: Please pay the overdraft first before you want to attend the preferential scheme.

Note 2: You can use your preferential scheme until the prepayment is run out.

Note 3: The preferential scheme is only used for the charges of self-operating, and manufacturing service excludes the consumables, license charges, and others.

Note 4: The charge is calculated by the unit of 15 minutes when the using time exceeds the necessary charge hours.

Instrument/ List of Charge		NTHU	Academics	Industry
	Charge of manufacturing service			
	Charge of Self-Operating			

# DLP Maskless Exposure System

[Back to](#)  
[【Instrument List】](#)

## 【Instrument introduction】

### 1. Manufactory & Model : ARMS (Japan) / UTA-III A

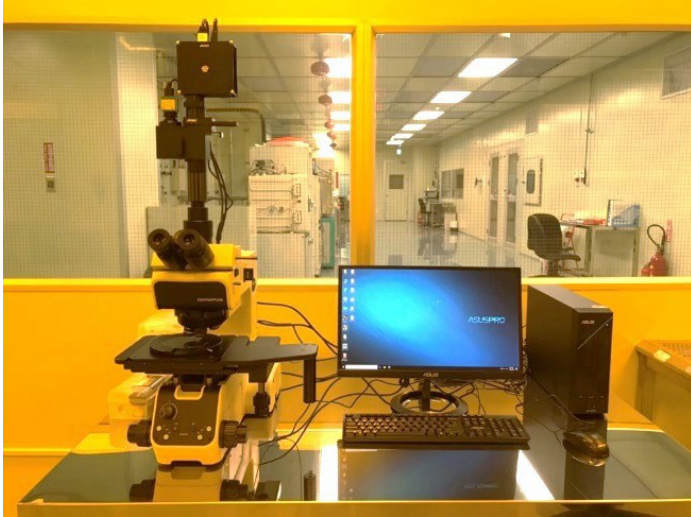

### 2. Specialities

- Because the lamp source is LED, you can exposure immediately without lamp pre-heating.
- DLP resolution is 1280 x 1024 pixels.
- Exposure process do not need the Mask.
- The pattern edit function is included in software.
- The min. line width can  $\leq 3\mu\text{m}$  depend on the lens magnification and PR.
- The single-side alignment accuracy limited on lens.
- The XY movement stage range is 75mm x 50mm.

#### ※ Notation

- Process relative materials (ex. PR) should be prepared by yourself.

## 【Service & Charge】

Preferential schemes (Effective Date: October 10, 2025):

【Generous discount】 : The professor/advisor who prepay 100,000 NT can have a 30% discount on self-operating charges and a 20% discount on manufacturing service.

【VIP discount】 : The professor/advisor who prepay 500,000 NT can have a 50% discount on self-operating and a 30% discount on manufacturing service.

Note 1: Please pay the overdraft first before you want to attend the preferential scheme.

Note 2: You can use your preferential scheme until the prepayment is run out.

Note 3: The preferential scheme is only used for the charges of self-operating, and manufacturing service excludes the consumables, license charges, and others.

Note 4: The charge is calculated by the unit of 15 minutes when the using time exceeds the necessary charge hours.

Instrument/ List of Charge		NTHU	Academics	Industry
DLP Maskless Exposure System (The minimum charge time is 1 hr. including "Spin, Baking, Startup, Shutdown and Process" )	Charge of manufacturing Service		NTD 75/min	NTD 100/min
	Charge of Self-Operating	NTD 32/min	NTD 48/min	NTD 64/min

## 【Instrument introduction】

### 1. Brand Model : EVG620

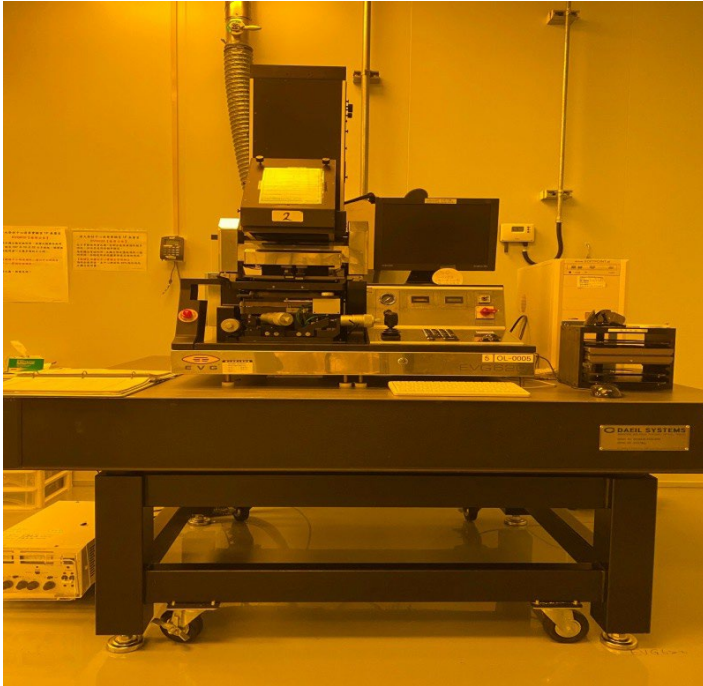

### 2. Application

Pattern transfer process

### 3. Important Specifications

- Wafer size : Si wafer(1~4inch) · Thickness between 0.1~2 mm
- Mask size : 5 inch mask size and the mask thickness must less than 4 mm
- Range of alignment : X, Y, Z : +/- 5 mm ; Rotation Theta : +/- 3.5°
- Alignment accuracy : Mask aligner:0.5um for top side alignment(With 20X obj)
- Exposure mode : soft contact, hard contact, vacuum contact
- Mercury lamp light source : Standard lamp power 350W.
- Exposure Intensity : 10mw/cm<sup>2</sup>
- Standard NUV for 350 – 450nm

#### ※Notification

Please prepare the demanded photoresist by yourself. CNMM only sells EPG512 and AZ4620 (Both of them are positive tone photoresist.)

## 【 Service & Charge 】

Preferential schemes (Effective Date: October 10, 2025):

【 Generous discount 】 : The professor/advisor who prepay 100,000 NT can have a 30% discount on self-operating charges and a 20% discount on manufacturing service.

【 VIP discount 】 : The professor/advisor who prepay 500,000 NT can have a 50% discount on self-operating and a 30% discount on manufacturing service.

Note 1: Please pay the overdraft first before you want to attend the preferential scheme.

Note 2: You can use your preferential scheme until the prepayment is run out.

Note 3: The preferential scheme is only used for the charges of self-operating, and manufacturing service excludes the consumables, license charges, and others.

Note 4: The charge is calculated by the unit of 15 minutes when the using time exceeds the necessary charge hours.

Instrument/ List of Charge		NTHU	Academics	Industry
EVG620  (The processing time includes the time of spin coating, baking, aligning, exposing, and lamp cooling. The necessary charge hours are 2 hours.)	Charge of manufacturing service	NTD 50/min	NTD 75/ min	NTD 100/ min
	Charge of Self-Operating	NTD 26/min	NTD 39/ min	NTD 52/ min

## 【Instrument introduction】

### 1. Brand and model : Nanonex / NX2000



### 2. Applications

Use hot pressing or illumination imprint to transfer the pattern.

### 3. Important specifications

- Imprint mode : Thermal curing, UV curing 4 inch wafer or broken sample
- Pneumatic pressurization : 0~600 psi
- Heating range of hot pressing : RT~200 °C
- 500 W Mercury lamp light source : 320~390 nm

#### ※ Notification

- User can contact with the center if need some help with the process flow.

**Preferential schemes (Effective Date: October 10, 2025):**

**【 Generous discount 】** : The professor/advisor who prepay 100,000 NT can have a 30% discount on self-operating charges and a 20% discount on manufacturing service.

**【 VIP discount 】** : The professor/advisor who prepay 500,000 NT can have a 50% discount on self-operating and a 30% discount on manufacturing service.

Note 1: Please pay the overdraft first before you want to attend the preferential scheme.

Note 2: You can use your preferential scheme until the prepayment is run out.

Note 3: The preferential scheme is only used for the charges of self-operating, and manufacturing service excludes the consumables, license charges, and others.

Note 4: The charge is calculated by the unit of 15 minutes when the using time exceeds the necessary charge hours.

Instrument/ List of Charge		NTHU	Academics	Industry
NX2000 Nano Imprint System (The processing time includes the time of spin coating, imprinting, and turing on and off process. The necessary charge hours are 2 hours.)	Charge of manufacturing service			
	Charge of Self-Operating	NTD 10/min	NTD 15/min	NTD 20/min

## 【Instrument introduction】

### 1. Manufactory & Model : ELIONIX INC. /ELS-7800



### 2. Applications

Use electron beam direct writing to transfer the designed circuit layout onto the specimen.

### 3. Important specifications

- Voltage: 80KeV
- Electric beam current: 10pA ~ 600pA
- Minimum line width: 20nm ( Tool resolution capability ) , 50nm (positive resist, 80-nm thickness ) , 70nm (positive resist, 200-nm thick
- Substrate size: 2 inch~6 inch full wafer or square specimen (specimen should be larger than 10x10mm<sup>2</sup> but smaller than 30x30mm<sup>2</sup>)

#### ※ Precautions

- The substrate should be electrically conductive. If not, a conductive layer is required. Please ask when request for a foundry service.

## 【Service & Charge】

**Preferential schemes (Effective Date: October 10, 2025):**

**【Generous discount】** : The professor/advisor who prepay 100,000 NT can have a 30% discount on self-operating charges and a 20% discount on manufacturing service.

**【VIP discount】** : The professor/advisor who prepay 500,000 NT can have a 50% discount on self-operating and a 30% discount on manufacturing service.

Note 1: Please pay the overdraft first before you want to attend the preferential scheme.

Note 2: You can use your preferential scheme until the prepayment is run out.

Note 3: The preferential scheme is only used for the charges of self-operating, and manufacturing service excludes the consumables, license charges, and others.

Note 4: The charge is calculated by the unit of 15 minutes when the using time exceeds the necessary charge hours.

Instrument/ List of Charge		NTHU	Academics	Industry	
E-beam lithography system <b>The minimum charge time is 2 hrs.</b>	manufacturing service	Basic Operation	NTD 3,000/2hrs	NTD 4,500/2hrs	NTD 6,000/2hrs
		Charge Counted	NTD 25/min	NTD 37/ min	NTD 50/ min
	Self-Operating	Basic Operation	NTD 2,880/2hrs	NTD 4,320/2hrs	NTD 5,760/2hrs
		Charge Counted	NTD 24/ min	NTD 36/ min	NTD 48/ min

**【Note】**

1. The qualification for operating this equipment is primarily for doctoral students or dedicated assistants. If there is a need for self-operation but the laboratory has no doctoral students or dedicated assistants, an application can be submitted to the center. After evaluation by the center, the advisor can assign one master student as the representative of the laboratory. Once licensed, the student can operate the equipment independently, but only one master student is allowed per laboratory..
2. Those who operate the machine by themselves or join the membership must be trained 5 times, and they can use the machine only after passing the assessment.
3. After obtaining the self-operation qualification, every six months, there must be record of use in order to renew the operation.

## 【Instrument introduction】

1. Brand and model : SAMCO · Model PC-300



2. Applications

PR etch

3. Important specifications

- Wafer size : Piece wafer · 4" wafer (max 12 piece) ~ 8" wafer (max 3 piece) °
- Power supply : Maximum 300 W °
- Gas : Ar · O<sub>2</sub> °
- Main pump : Rotary pump °

## 【Service & Charge】

**Preferential schemes (Effective Date: October 10, 2025):**

**【Generous discount】** : The professor/advisor who prepay 100,000 NT can have a 30% discount on self-operating charges and a 20% discount on manufacturing service.

**【VIP discount】** : The professor/advisor who prepay 500,000 NT can have a 50% discount on self-operating and a 30% discount on manufacturing service.

Note 1: Please pay the overdraft first before you want to attend the preferential scheme.

Note 2: You can use your preferential scheme until the prepayment is run out.

Note 3: The preferential scheme is only used for the charges of self-operating, and manufacturing service excludes the consumables, license charges, and others.

Note 4: The charge is calculated by the unit of 15 minutes when the using time exceeds the necessary charge hours.

Instrument/ List of Charge		NTHU	Academics	Industry
O <sub>2</sub> Plasma Cleaning System <b>(The processing time includes the time of etching and cleaning. The necessary charge hour is 1 hour.)</b>	Charge of manufacturing service	NTD 20/min	NTD 30/min	NTD 40/min
	Charge of Self-Operating	NTD 10/ min	NTD 15/min	NTD 20/min

## 【Instrument introduction】

### 1. Brand and model : Premtex RTP-S61-M



### 2. Applications

Carrier Disk Type	Annealing Material	Gas
Carrier A:SiC Pollution-free Process	Oxide/nitride/silicon..etc.	All
Carrier B:Graphite (with cover) Dirty Process	Metal structure/III- V compounds....etc	NO O2
Note		
<p>1. Prohibit organic/low melting point/volatile materials.</p> <p>2. The carrier B belongs to dirty process, so be sure to cover it when operating the system</p> <p>3. Please select the "correct" carrier when using to avoid chamber contamination.</p> <p>4. Handle the carrier carefully.</p> <p>If you have any questions about the above, please contact us.</p>		

### 3. Specifications

Wafer size : Piece wafer、4" wafer~ 6" wafer

Maximal Ramping Speed:

- 40°C/sec for Graphite
- 30°C/sec for SiC

Process Temperature:200~1000°C

Maximal Process Time:

- T<500°C:10min
- T<800°C:5min
- T<1000°C:3min

Process Gas :

- N2 3SLM/ N2 30SLM
- O2 500SCCM/ Ar 500SCCM

## 【Service &amp; Charge】

**Preferential schemes (Effective Date: October 10, 2025):**

**【Generous discount】** : The professor/advisor who prepay 100,000 NT can have a 30% discount on self-operating charges and a 20% discount on manufacturing service.

**【VIP discount】** : The professor/advisor who prepay 500,000 NT can have a 50% discount on self-operating and a 30% discount on manufacturing service.

Note 1: Please pay the overdraft first before you want to attend the preferential scheme.

Note 2: You can use your preferential scheme until the prepayment is run out.

Note 3: The preferential scheme is only used for the charges of self-operating, and manufacturing service excludes the consumables, license charges, and others.

Note 4: The charge is calculated by the unit of 15 minutes when the using time exceeds the necessary charge hours.

Instrument/ List of Charge		NTHU	Academics	Industry
RTP System  (The processing time includes the time of vacuuming, heating, annealing and cooling. The necessary charge hour is 1 hour.)	Charge of manufacturing service	NTD 20/min	NTD 30/min	NTD 40/min
	Charge of Self-Operating	NTD 10/min	NTD 15/min	NTD 20/min

# UV & Ozone Dry Stripper

[Back to](#)  
[【Instrument List】](#)

## 【Instrument introduction】

### 1. Brand and model : SAMCO UV-1



### 2. Applications

Wafer surface cleaning

### 3. Important specifications

- Applicable for III-V wafer and wafer which contains metals.
- Gas : O<sub>2</sub>

## 【Service & Charge】

**Preferential schemes (Effective Date: October 10, 2025):**

**【Generous discount】** : The professor/advisor who prepay 100,000 NT can have a 30% discount on self-operating charges and a 20% discount on manufacturing service.

**【VIP discount】** : The professor/advisor who prepay 500,000 NT can have a 50% discount on self-operating and a 30% discount on manufacturing service.

Note 1: Please pay the overdraft first before you want to attend the preferential scheme.

Note 2: You can use your preferential scheme until the prepayment is run out.

Note 3: The preferential scheme is only used for the charges of self-operating, and manufacturing service excludes the consumables, license charges, and others.

Note 4: The charge is calculated by the unit of 15 minutes when the using time exceeds the necessary charge hours.

Instrument/ List of Charge		NTHU	Academics	Industry
UV & Ozone Dry Stripper The processing time includes the time of heating, stripping/etching, and cooling. The necessary charge hour is a half-hour.)	Charge of manufacturing service	NTD 17/min	NTD 25/min	NTD 34/min
	Charge of Self-Operating	NTD 3/min	NTD 5/min	NTD 6/min

# Field Emission Scanning Electron Microscope (JSM-7000F)

[Back to](#)

[【Instrument List】](#)

## 【Instrument introduction】

### 1. 廠牌型號：

Brand : JSM-7000F, JAPAN ELECTRON OPTICS LABORATORY CO., LTD. (JEOL) ◦



### 2. Application

- Micro structures inspection on the various samples such as metal, ceramics and polymer, etc.
- An additional component of energy dispersive spectrometer (EDS) of X-ray provides a quantitative identification and semi-quantitative analysis of sample elements.

### 3. Specification

- Voltage : 0.5 to 30 KV ◦
- Magnification : 30 to 250000 ◦
- Resolution : 1.2 nm (30 KV) 、 1.5 nm (15 KV) 、 3.0 nm (1KV) ◦

### 4. Auto Fine Coater

The JEOL JFC-1600 Auto Fine Coater is designed to coat non-conductive specimens, such as biological specimens primarily for use in scanning electron microscope with high efficiency within a short time.



# Field Emission Scanning Electron Microscope (JSM-7000F)

## 【Service & Charge】

[Back to  
【Instrument List】](#)

**Preferential schemes (Effective Date: October 10, 2025):**

**【Generous discount】** : The professor/advisor who prepay 100,000 NT can have a 30% discount on self-operating charges and a 20% discount on manufacturing service.

**【VIP discount】** : The professor/advisor who prepay 500,000 NT can have a 50% discount on self-operating and a 30% discount on manufacturing service.

Note 1: Please pay the overdraft first before you want to attend the preferential scheme.

Note 2: You can use your preferential scheme until the prepayment is run out.

Note 3: The preferential scheme is only used for the charges of self-operating, and manufacturing service excludes the consumables, license charges, and others.

Note 4: The charge is calculated by the unit of 15 minutes when the using time exceeds the necessary charge hours.

Note5: **The fee schedule has been effective since May 15, 2025.**

Instrument/ List of Charge		NTHU	Academics	Industry
Field Emission Scanning Electron Microscope  (The necessary charge hour is 1 hour for manufacturing service and self-operating respectively.)  (The necessary charge hours are 2 hours for visiting activites.)	Charge of Characterization Service	Use JSM-IT800		
		<b>【Fee of report】</b> An additional NTD2000 is required for CNMM formal report.		
	Charge of Self-Operating	NTD 1,000/hr	NTD 2,000/hr	NTD 3,600/hr
	Auto Fine coater	NTD 200/10mins	NTD 300/10mins	NTD 400/10mins

## 【Instrument introduction】

[Back to  
【Instrument List】](#)

## 【Service & Charge】

[Back to  
【Instrument List】](#)

### Preferential schemes:

**【Generous discount】** : The professor/advisor who prepay 50,000 NT can have a 50% discount on self-operating charges and a 20% discount on manufacturing service.

**【VIP discount】** : The professor/advisor who prepay 500,000 NT can have a 70% discount on self-operating and a 35% discount on manufacturing service.

Note 1: Please pay the overdraft first before you want to attend the preferential scheme.

Note 2: You can use your preferential scheme until the prepayment is run out.

Note 3: The preferential scheme is only used for the charges of self-operating, and manufacturing service excludes the consumables, license charges, and others.

Note 4: The charge is calculated by the unit of 15 minutes when the using time exceeds the necessary charge hours.

Instrument/ List of Charge		NTHU	Academics	Industry

## 【Instrument introduction】

### 1. Brand : SEIKO SPA-300HV

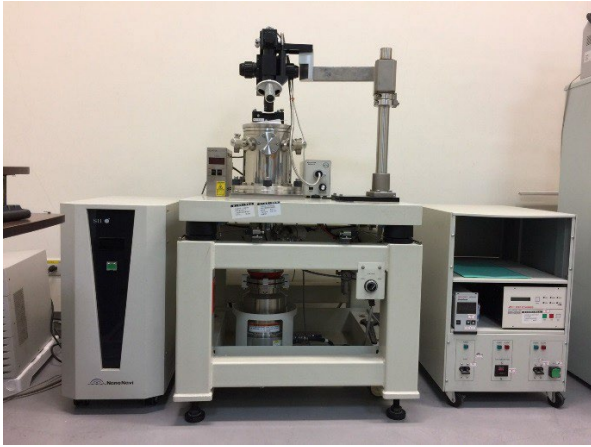

### 2. Specification

#### (1) Hardware control system

- Scan speed: 0.05 ~ 125 Hz ; nm ~  $\mu\text{m}$  /sec ◦
- Scan rotation : 360 degree ( $\pm 0.1$ degree) ◦
- Bias on the sample  $\pm 10\text{V}$  ◦
- Control resolution: X-Y :18 bits DAC  $\pm 200\text{V}$  ; Z : 21 bits DAC  $\pm 200\text{V}$  ◦

#### (2) Scanner: 20 $\mu\text{m}$ scanner

- Scan area: horizontal nm~20 $\mu\text{m}$ , vertical: ~1.6 $\mu\text{m}$
- resolution  $\leq 0.2\text{nm}$  , vertical resolution  $\leq 0.01\text{nm}$  ◦
- sample size  $\leq 35\text{mm}$  dimension 1 cm x thickness 10mm ◦
- Manual mechanical movement range:  $\pm 2.5$  cm.

### 3.. 儀器功能

1. Atomic Force Microscope (AFM)
2. Dynamic Force Microscope (DFM)
3. FFM (Friction Force Microscopy)
4. Vector Scan (Lithography)
5. MFM ( Magnetic Force Microscopy )
6. PFM ( Piez Response Microscopy )
7. KFM ( Kelvin Force Microscopy )
8. ( Conductive-AFM )

# High Vacuum Scanning Probe Microscope (SPM)

[Back to](#)  
[【Instrument List】](#)

## 【Service & Charge】

**Preferential schemes (Effective Date: October 10, 2025):**

**【Generous discount】** : The professor/advisor who prepay 100,000 NT can have a 30% discount on self-operating charges and a 20% discount on manufacturing service.

**【VIP discount】** : The professor/advisor who prepay 500,000 NT can have a 50% discount on self-operating and a 30% discount on manufacturing service.

Note 1: Please pay the overdraft first before you want to attend the preferential scheme.

Note 2: You can use your preferential scheme until the prepayment is run out.

Note 3: The preferential scheme is only used for the charges of self-operating, and manufacturing service excludes the consumables, license charges, and others.

Note 4: The charge is calculated by the unit of 15 minutes when the using time exceeds the necessary charge hours.

Instrument/ List of Charge		NTHU	Academics	Industry
High Vacuum Scanning Probe Microscope  (The necessary charge hours are 2 hour and 2 hours for manufacturing service and self- operating respectively.)	Charge of Characterization Service	NTD 1,500/hr	NTD 2,250/ hr	NTD 3,000/ hr
		<b>The processing time includes the time of pretreatment, measuring, and data processing.</b>		
	<b>【Fee of report】</b> An additional NTD2000 is required for CNMM formal report.			
	Charge of Self-Operating	NTD 750/ hr	NTD 1,125/ hr	NTD 1,500/ hr
Probe Cost	Self-supplied or purchased from CNMM			

\*Probes can be provided by users or purchased from the Center.

Effective from February 2, 2026, the probe fee is:

Internal users: NTD 1,300 per probe;

External users: NTD 1,600 per probe.

(Users are encouraged to bring their own probes. Probes provided by the Center are mainly for beginners or emergency use and are priced higher.)

# High Resolution Transmission Electron Microscope (HRTEM)

## 【Instrument introduction】

[Back to](#)  
[【Instrument List】](#)



1. Model : JEOL JEM-F200

### 2. Performance

- Acceleration voltage : 200KV and 80KV ◦
- Type : Cold Field Emission Gun ◦
- TEM Point resolution : 0.19nm@200KV ◦
- TEM lattice resolution : 0.10nm@200KV and 0.14nm@80KV ◦
- STEM Lattice resolution : 0.14nm@200KV and 0.31nm@80KV ◦
- STEM Detectors : DF, BF(ABF) and BEI ◦
- Double tilted holder ◦

# High Resolution Transmission Electron Microscope (HRTEM)

## 【Service & Charge】

[Back to](#)  
[【Instrument List】](#)

Instrument/ List of Charge		NTHU	Academics	Industry
High Resolution Transmission Electron Microscope <b>(The necessary charge hours are 3 hours.)</b>	Charge of Characterization Service	NTD 18,000/pic		
	Charge of Self-Operating	No self- operating	No self- operating	No self- operating

# Dual-beam Focused Ion Beam system (FIB)

## 【Instrument introduction】

[Back to](#)  
[【Instrument List】](#)

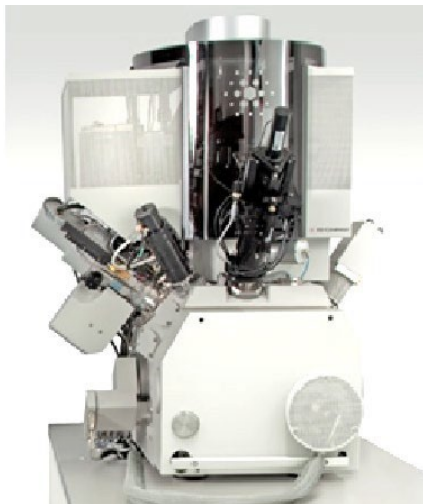

1. Model : FEI Helios Nanolab 600i System

### 2. Application

- For TEM specimens preparation
- Nano structure manufacturing
- Deposition for circuit repair
- Cross-section observed

### 3. Performance

	SEM	FIB
Acceleration voltage	350V -30 KV	500V -30 KV
Probe current	0-22 nA	1.1 pA – 65 nA
Resolution	< 0.9 nm (15 KV) < 1.4 nm (1 KV)	< 4 nm (30KV)
GIS	Pt	
Omniprobe 200		
Energy Dispersive Spectrometer (EDS)		

### 4. Self-operating license

- Restricted to master' s and doctoral students at NTHU, as well as postdoctoral researchers, who are licensed to use scanning electron microscopes.
- Eligible students/researchers can register through the contact information below.
- Registration contact: Ms. Lai, CNMM, National Tsing Hua University
- (Room 520, Innovation Incubation Building, National Tsing Hua University,
- ext. 42287, siyilai@mx.nthu.edu.tw)
- Restricted to three FIB licenses per laboratory.
- After completing the training and qualification process, users may obtain a self-operation license.
- After obtaining the self-operation license, users are responsible for any damages caused by operational errors.

# Dual-beam Focused Ion Beam system (FIB)

## 【Service & Charge】

[Back to](#)  
[【Instrument List】](#)

Instrument/ List of Charge		NTHU	Academics	Industry	
Dual-beam Focused Ion Beam System (FIB ) (Characterization service: The necessary charge hours are 3 hours. The charge is calculated by the unit of an hour when the using time exceeds the necessary charge hours. Self-operating: The necessary charge hours are 3 hours. The charge is calculated by the unit of 15 minutes when the using time exceeds the necessary charge hours.)	Charge of Characterization Service	General user	NTD2,000/hr	NTD 3,500/hr	NTD 6,000/hr
		VIP user	Prepayment of 100,000 NT, you get a 20% off discount.		Prepayment of 300,000 NT, you get a 20% off discount.
	Charge of Self-Operating	General user	A 25% off discount of 2,000 NTD/hr	No self-operating	No self-operating
		VIP user	【 Prepayment of 100,000 NT, you get a 40% off discount. 】 【 Prepayment of 300,000 NT, you get a 50% off discount. 】	No self-operating	No self-operating
	Consumable cost	Depositing platinum on the sample is free when the deposition time is not over 6 minutes. Or it will be additionally charged 100 NT for each minute when the time exceeds 6 minutes.			

If Auto Fine Coater is necessary due to the poor conductivity, please refer to the charge of Field Emission Scanning Electron Microscope (JSM-IT800) of CNMM.

## 【Instrument introduction】

1. Brand : Oriel class A, 91160A, Newport Corporation

Solar simulation is used to measure the photoelectric conversion of solar cells.

The intensity of standard solar is defined as 100 mW/cm<sup>2</sup> AM 1.5G. Standard solar cell is supported to calibrate the intensity of solar simulator before measurement ◦

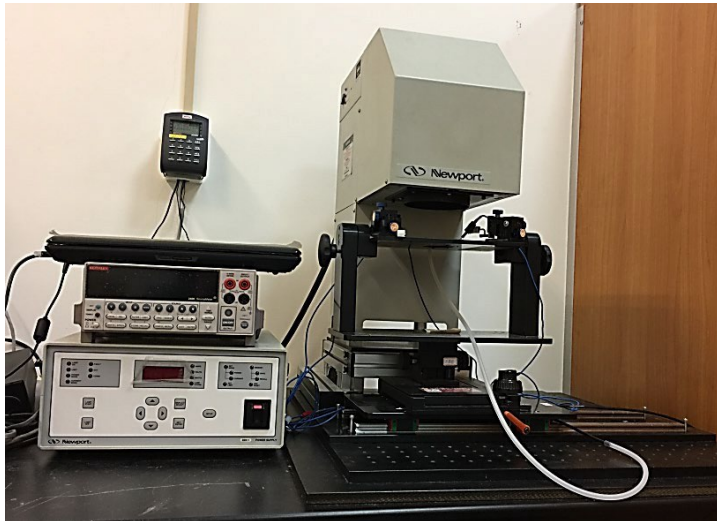

## 2. Specification

- Simulator Type: Full Spectrum Solar Simulator ◦
- Lamp Type: 300 W Xenon, Short Arc ◦
- Beam Size: 2 x 2 in. (51 x 51 mm) ◦
- Collimation:  $< \pm 10^\circ$  ◦

## 【Service & Charge】

**Preferential schemes (Effective Date: October 10, 2025):**

**【Generous discount】** : The professor/advisor who prepay 100,000 NT can have a 30% discount on self-operating charges and a 20% discount on manufacturing service.

**【VIP discount】** : The professor/advisor who prepay 500,000 NT can have a 50% discount on self-operating and a 30% discount on manufacturing service.

Note 1: Please pay the overdraft first before you want to attend the preferential scheme.

Note 2: You can use your preferential scheme until the prepayment is run out.

Note 3: The preferential scheme is only used for the charges of self-operating, and manufacturing service excludes the consumables, license charges, and others.

Note 4: The charge is calculated by the unit of 15 minutes when the using time exceeds the necessary charge hours.

Instrument/ List of Charge		NTHU	Academics	Industry
Solar Simulator (The necessary charge hour is 1 hour.)	Charge of Characterization Service	NTD 750/hr	NTD 1,125/hr	NTD 1,500/hr
	Charge of Self-Operating	NTD 400/hr	NTD 600/hr	NTD 800/hr

1. **Brand** : ENLI, EQE-D-3011, ENLI Technology Co., Ltd

IPCE (Incident Photon-to-electron Conversion Efficiency) is the conversion ratio of the incident photon to electron by a photovoltaic cell.



## 2. Specification

- Wavelength range: 350-1100 (nm) ◦
- Wavelength interval: adjustable, 1-50(nm), (Default 5 nm) ◦
- Chopping frequency: adjustable, (4~5 kHz, MCU controlled) ◦
- Auto Jsc calculation with reference solar spectrum or consumer input ◦
- S/N ratio > 500 ◦
- Precision, error bar: < 2% ◦
- Repeatability: > 95% ◦
- Light Bias: Optional component ◦
- Voltage Bias: Optional component ◦
- Rapid: < 4 min for one trip measurement, 300-1100 nm ◦
- Lamp lifetime: QTH lamp-2000hrs ◦

## 【Service & Charge】

**Preferential schemes (Effective Date: October 10, 2025):**

**【Generous discount】** : The professor/advisor who prepay 100,000 NT can have a 30% discount on self-operating charges and a 20% discount on manufacturing service.

**【VIP discount】** : The professor/advisor who prepay 500,000 NT can have a 50% discount on self-operating and a 30% discount on manufacturing service.

Note 1: Please pay the overdraft first before you want to attend the preferential scheme.

Note 2: You can use your preferential scheme until the prepayment is run out.

Note 3: The preferential scheme is only used for the charges of self-operating, and manufacturing service excludes the consumables, license charges, and others.

Note 4: The charge is calculated by the unit of 15 minutes when the using time exceeds the necessary charge hours.

Instrument/ List of Charge		NTHU	Academics	Industry
Incident Photon Conversion Efficiency (The necessary charge hour is 1 hour.)	Charge of Characterization Service	NTD 750/hr	NTD 1,125/hr	NTD 1,500/hr
	Charge of Self-Operating	NTD 400/hr	NTD 600/hr	NTD 800/hr

## 【 Instrument introduction 】

### 1. Brand Model : EVG610

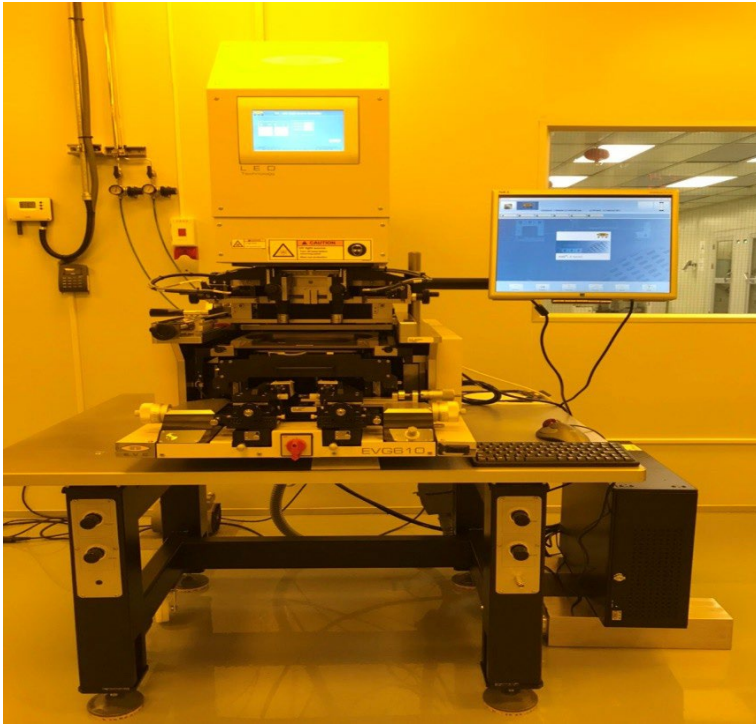

### 2. Application

Pattern transfer process

### 3. Important Specifications

- Wafer size : 4-inch or 6-inch Full wafer. Thickness between 0.1~10 mm.  
(If the substrate is not a full wafer, please stick it on 4-inch or 6-inch full wafer.)
- Mask size : 5-inch or 7-inch mask. the mask thickness must less than 4 mm
- Exposure platform uniformity : 6-inch full wafer range  $\leq 3\%$
- Thickness 1  $\mu\text{m}$  photoresist resolution (soft contact mode) : Single line  $\leq 3\mu\text{m}$
- Top-side alignment accuracy :  $\pm 1 \mu\text{m}$   
(Top side microscope movement range X : 32~150 mm ; Y : -75~30 mm)
- Bottom-side alignment accuracy :  $\pm 2 \mu\text{m}$   
(Bottom side microscope movement range X : 30~100 mm ; Y : -10~10 mm)
- Exposure mode : proximity, soft contact, hard contact, vacuum contact
- LED exposure Intensity : 35  $\text{mw}/\text{cm}^2$

#### ※Notification

Please prepare the demanded photoresist by yourself. CNMM only sells EPG512 and AZ4620 (Both of them are positive tone photoresist.)

## 【Service & Charge】

Preferential schemes (**Effective Date: October 10, 2025**):

**【Generous discount】** : The professor/advisor who prepay 100,000 NT can have a 30% discount on self-operating charges and a 20% discount on manufacturing service.

**【VIP discount】** : The professor/advisor who prepay 500,000 NT can have a 50% discount on self-operating and a 30% discount on manufacturing service.

Note 1: Please pay the overdraft first before you want to attend the preferential scheme.

Note 2: You can use your preferential scheme until the prepayment is run out.

Note 3: The preferential scheme is only used for the charges of self-operating, and manufacturing service excludes the consumables, license charges, and others.

Note 4: The charge is calculated by the unit of 15 minutes when the using time exceeds the necessary charge hours.

Instrument/ List of Charge		NTHU	Academics	Industry
EVG610 (The processing time includes the time of spin coating, baking, aligning and exposing. The necessary charge hour is 1 hour.)	Charge of manufacturing service	NTD 50/min	NTD 75/ min	NTD 100/ min
	Charge of Self-Operating	NTD 26/min	NTD 39/ min	NTD 52/ min

# E-Gun Evaporation System (III)

[Back to](#)  
[\[Instrument List\]](#)

## 【Instrument introduction】

### 1. Brand and model : EGION TE20001



### 2. Application

E-gun evaporate the Al, Ti, Au, Pt, Cr etc. metal films(Nonopen to use self-provided crucible and source), and you can choose to clean sample surface by ion source before depositing.

### 3. Specifications

- (1) Operating pressure:  $< 3 \times 10^{-6}$  torr
- (2) Evaporate rate : 1 A/s
- (3) Crucible size: 15 c.c.
- (4) 4-inch wafer(at most 6wafer), or 6-inch wafer(at most 4 wafer)
- (5) Fragment should be fixed on 4-inch or 6-inch wafer. (A wafer can be bought in the center. 800 TWD for one 4-inch wafer.)

#### Metal charging standards :

Equipment name	service		NTHU	Other academic circles	Industry
e-gun III target material expenses	General metal	Al	NT\$150/10min	NT\$200/10min	NT\$250/10min
		Cr、Ti	NT\$250/10min	NT\$380/10min	NT\$500/10min
	service		NTHU		OTHERS
	Precious metal	Au	NT\$7,641/10min	NT\$9,551/10min	
		Pt	NT\$3000/10min	NT\$3750/10min	

1. The upper limit of OEM materials charge is 30min, exclusive of special OEM charge.
2. The above is reference price, and the actual price is adjusted according to the fluctuation of the material.
3. Effective May 1, 2026, charges for noble metals will be calculated based on the actual weight used.
4. Prices are subject to change according to market rates without prior notice.

If the target material is damaged, the user shall be fully liable for compensation, so please confirm the target material with the assistant when taking it out or returning it.

## 【Service & Charge】

**Preferential schemes (Effective Date: October 10, 2025):**

**【Generous discount】** : The professor/advisor who prepay 100,000 NT can have a 30% discount on self-operating charges and a 20% discount on manufacturing service.

**【VIP discount】** : The professor/advisor who prepay 500,000 NT can have a 50% discount on self-operating and a 30% discount on manufacturing service.

**【Note 1】**

Those who want to enjoy the latest preferential program must have no debts.

**【Note 2】**

The pre-payment has no expiration date; however, when the payment is used out, it will cost the original price.

**【Note 3】**

The advance payment is for special funds only; the discount does not include consumables and access fees.

**【Note 4】**

After exceeding the minimum usage time, billing will be made every 15 minutes.

Instrument/ List of Charge		NTHU	Academics	Industry
E-Gun Evaporation System III  (Vacuuming, cooling and operating time are included in the billing, and the minimum usage time is 2hr)	Charge of manufacturing service	NTD 40/min	NTD 60/min	NTD 80/min
		Material fee is extra		
	Charge of Self-Operating	NTD 20/min	NTD 30/min	NTD 40/min

# Zeiss Crossbeam FIB system

## 【Instrument introduction】

[Back to](#)  
[【Instrument List】](#)

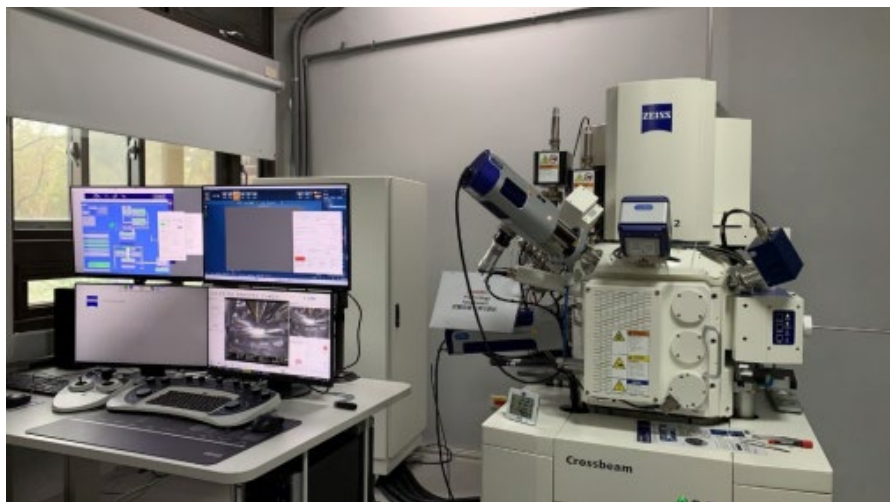

### 1. Model : Zeiss Crossbeam System

### 2. Application

- For TEM specimens preparation
- Nano structure manufacturing
- Deposition for circuit repair
- Cross-section observed
- EDS: Identification and quantification of the elements present in a sample
- EBSD: Analysis of the crystallographic orientation and microstructure of crystalline materials

### 3. Performance

	SEM	FIB
Acceleration voltage	350V -30 KV	500V -30 KV
Probe current	0-22 nA	1 pA – 100 nA
GIS	Pt/C	
Omniprobe 400		
Energy Dispersive Spectrometer (EDS)		
Electron Backscattered Diffraction (EBSD)		
Cryo stage (Not open)		

### 4. Self-operating license

- Restricted to master' s and doctoral students at NTHU, as well as postdoctoral researchers, who are licensed to use scanning electron microscopes.
- Eligible students/researchers can register through the contact information below.
- Registration contact: Ms. Lai, CNMM, National Tsing Hua University
- (Room 520, Innovation Incubation Building, National Tsing Hua University,
- ext. 42287, siyilai@mx.nthu.edu.tw)
- Restricted to three FIB licenses per laboratory.
- After completing the training and qualification process, users may obtain a self-operation license.
- After obtaining the self-operation license, users are responsible for any damages caused by operational errors.

### Promotional Launch Price for ZEISS FIB (Effective from May 1, 2026)

Instrument/ List of Charge		Academics	Industry	
Zeiss Crossbeam FIB System (Characterization service: The necessary charge hours are 3 hours. The charge is calculated by the unit of an hour when the using time exceeds the necessary charge hours. Self-operating: The necessary charge hours are 3 hours. The charge is calculated by the unit of 15 minutes when the using time exceeds the necessary charge hours.)	<b>Charge of Characterization Service</b>	General user	NTD2,000/hr	NTD 7,500/hr
		VIP user (NTHU only)	Prepayment of 100,000 NT, you get a 20% off discount.	Prepayment of 300,000 NT, you get a 20% off discount.
	<b>Charge of Self-Operating (NTHU only)</b>	General user	A 25% off discount of 2,000 NTD/hr	-
		VIP user	【Prepayment of 100,000 NT, you get a 40% off discount.】 【Prepayment of 300,000 NT, you get a 50% off discount.】	-
	<b>Consumable cost</b>		Depositing platinum on the sample is free when the deposition time is not over 6 minutes. Or it will be additionally charged 100 NT for each minute when the time exceeds 6 minutes.	
			Depositing carbon on the sample is charged 300 NT for each time.	
	<b>Lift-out Cu grid</b>		NT 200 for each	

If Auto Fine Coater is necessary due to the poor conductivity, please refer to the charge of Field Emission Scanning Electron Microscope (JSM-IT800) of CNMM.

